

**Full - Bridge
NPT & Trench + Field Stop® IGBT
Power module**

Trench & Field Stop® IGBT Q1, Q3:
 $V_{CES} = 1200V$; $I_C = 50A$ @ $T_c = 80^\circ C$

Fast NPT IGBT Q2, Q4:
 $V_{CES} = 1200V$; $I_C = 50A$ @ $T_c = 80^\circ C$

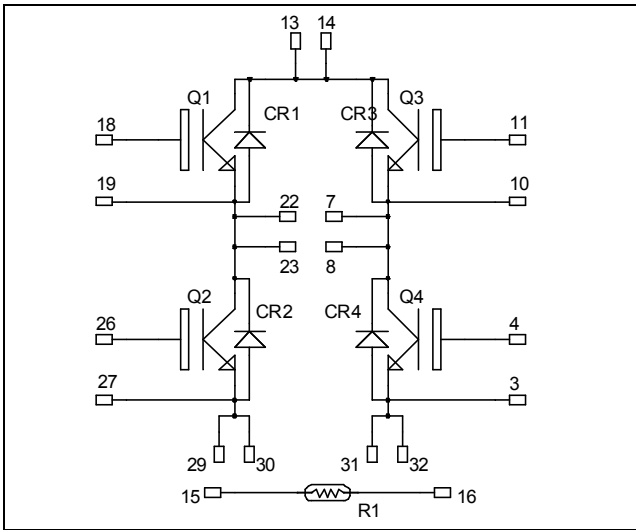

Top switches : Trench + Field Stop IGBT®
Bottom switches : FAST NPT IGBT®

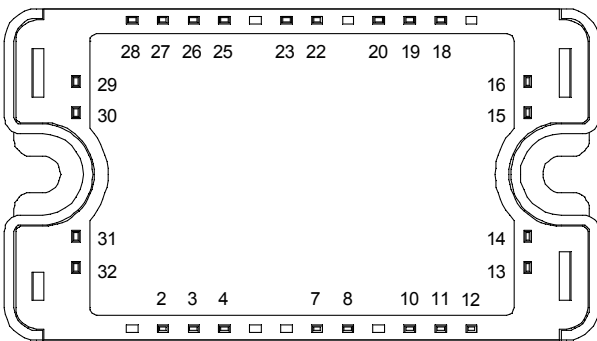

All multiple inputs and outputs must be shorted together
13/14 ; 15/16 ; 26/27 ; 31/32

Application

- Solar converter

Features

- **Q2, Q4 (FAST Non Punch Through (NPT) IGBT)**
 - Switching frequency up to 50 kHz
 - RBSOA & SCSOA rated
 - Low tail current
- **Q1, Q3 (Trench & Field Stop IGBT®)**
 - Low voltage drop
 - Switching frequency up to 20 kHz
 - RBSOA & SCSOA rated
 - Low tail current

- Kelvin emitter for easy drive
- Very low stray inductance
- High level of integration
- Internal thermistor for temperature monitoring

Benefits

- Optimized conduction & switching losses
- Direct mounting to heatsink (isolated package)
- Low junction to case thermal resistance
- Solderable terminals both for power and signal for easy PCB mounting
- Low profile
- Easy paralleling due to positive T_C of V_{CESat}
- RoHS Compliant

CAUTION: These Devices are sensitive to Electrostatic Discharge. Proper Handling Procedures Should Be Followed. See application note APT0502 on www.microsemi.com

All ratings @ $T_j = 25^\circ\text{C}$ unless otherwise specified

1. Top switches
1.1 Top Trench + Field Stop IGBT[®] characteristics
Absolute maximum ratings

Symbol	Parameter	Max ratings	Unit
V_{CES}	Collector - Emitter Breakdown Voltage	1200	V
I_C	Continuous Collector Current	$T_C = 25^\circ\text{C}$	75
		$T_C = 80^\circ\text{C}$	50
I_{CM}	Pulsed Collector Current	$T_C = 25^\circ\text{C}$	100
V_{GE}	Gate - Emitter Voltage	± 20	V
P_D	Maximum Power Dissipation	$T_C = 25^\circ\text{C}$	270
RBSOA	Reverse Bias Safe Operating Area	$T_j = 125^\circ\text{C}$	100A @ 1150V

Electrical Characteristics

Symbol	Characteristic	Test Conditions	Min	Typ	Max	Unit
I_{CES}	Zero Gate Voltage Collector Current	$V_{GE} = 0\text{V}$ $V_{CE} = 1200\text{V}$	$T_j = 25^\circ\text{C}$			250
			$T_j = 125^\circ\text{C}$			500
$V_{CE(sat)}$	Collector Emitter saturation Voltage	$V_{GE} = 15\text{V}$ $I_C = 50\text{A}$	$T_j = 25^\circ\text{C}$	1.4	1.7	2.1
			$T_j = 125^\circ\text{C}$		2.0	
$V_{GE(th)}$	Gate Threshold Voltage	$V_{GE} = V_{CE}, I_C = 2\text{mA}$	5.0	5.8	6.5	
I_{GES}	Gate - Emitter Leakage Current	$V_{GE} = 20\text{V}, V_{CE} = 0\text{V}$			400	

Dynamic Characteristics

Symbol	Characteristic	Test Conditions	Min	Typ	Max	Unit
C_{ies}	Input Capacitance	$V_{GE} = 0\text{V}, V_{CE} = 25\text{V}$		3600		pF
C_{rss}	Reverse Transfer Capacitance	$f = 1\text{MHz}$		160		
$T_{d(on)}$	Turn-on Delay Time	Inductive Switching (25°C) $V_{GE} = \pm 15\text{V}$ $V_{Bus} = 600\text{V}$ $I_C = 50\text{A}$ $R_G = 18\Omega$		90		ns
T_r	Rise Time			30		
$T_{d(off)}$	Turn-off Delay Time			420		
T_f	Fall Time			70		
$T_{d(on)}$	Turn-on Delay Time	Inductive Switching (125°C) $V_{GE} = \pm 15\text{V}$ $V_{Bus} = 600\text{V}$ $I_C = 50\text{A}$ $R_G = 18\Omega$		90		ns
T_r	Rise Time			50		
$T_{d(off)}$	Turn-off Delay Time			520		
T_f	Fall Time			90		
E_{on}	Turn-on Switching Energy	$V_{GE} = \pm 15\text{V}$ $V_{Bus} = 600\text{V}$ $I_C = 50\text{A}$ $R_G = 18\Omega$	$T_j = 125^\circ\text{C}$	5		mJ
E_{off}	Turn-off Switching Energy		$T_j = 125^\circ\text{C}$	5.5		
R_{thJC}	Junction to Case Thermal resistance				0.45	$^\circ\text{C/W}$

1.2 Top fast diode characteristics

<i>Symbol</i>	<i>Characteristic</i>	<i>Test Conditions</i>		<i>Min</i>	<i>Typ</i>	<i>Max</i>	<i>Unit</i>	
V_{RRM}	Maximum Peak Repetitive Reverse Voltage			1200			V	
I_{RM}	Maximum Reverse Leakage Current	$V_R=1200V$	$T_j = 25^\circ C$			100	μA	
			$T_j = 125^\circ C$			500		
I_F	DC Forward Current	$T_c = 80^\circ C$			60		A	
V_F	Diode Forward Voltage	$I_F = 60A$			2.5	3	V	
		$I_F = 120A$			3			
		$I_F = 60A$	$T_j = 125^\circ C$		1.8			
t_{rr}	Reverse Recovery Time	$I_F = 60A$	$V_R = 800V$	$di/dt = 200A/\mu s$	$T_j = 25^\circ C$		265	ns
					$T_j = 125^\circ C$			
Q_{rr}	Reverse Recovery Charge	$I_F = 60A$	$V_R = 800V$	$di/dt = 200A/\mu s$	$T_j = 25^\circ C$		560	nC
					$T_j = 125^\circ C$			
R_{thJC}	Junction to Case Thermal resistance					0.9	$^\circ C/W$	

2. Bottom switches
2.1 Bottom Fast NPT IGBT characteristics
Absolute maximum ratings

<i>Symbol</i>	<i>Parameter</i>	<i>Max ratings</i>		<i>Unit</i>
V_{CES}	Collector - Emitter Breakdown Voltage	1200		V
I_C	Continuous Collector Current	$T_c = 25^\circ C$	70	A
		$T_c = 80^\circ C$	50	
I_{CM}	Pulsed Collector Current	$T_c = 25^\circ C$	150	
V_{GE}	Gate - Emitter Voltage	± 20		V
P_D	Maximum Power Dissipation	$T_c = 25^\circ C$	312	W
RBSOA	Reverse Bias Safe Operating Area	$T_j = 150^\circ C$	100A @ 1200V	

Electrical Characteristics

<i>Symbol</i>	<i>Characteristic</i>	<i>Test Conditions</i>		<i>Min</i>	<i>Typ</i>	<i>Max</i>	<i>Unit</i>
I_{CES}	Zero Gate Voltage Collector Current	$V_{GE} = 0V$	$V_{CE} = 1200V$	$T_j = 25^\circ C$		250	μA
				$T_j = 125^\circ C$			
$V_{CE(sat)}$	Collector Emitter saturation Voltage	$V_{GE} = 15V$	$I_C = 50A$	$T_j = 25^\circ C$		3.2	V
				$T_j = 125^\circ C$			
$V_{GE(th)}$	Gate Threshold Voltage	$V_{GE} = V_{CE}, I_C = 1 mA$		4.5		6.5	V
I_{GES}	Gate - Emitter Leakage Current	$V_{GE} = 20 V, V_{CE} = 0V$				100	nA

Dynamic Characteristics

Symbol	Characteristic	Test Conditions	Min	Typ	Max	Unit
C _{ies}	Input Capacitance	V _{GE} = 0V		3450		pF
C _{oes}	Output Capacitance	V _{CE} = 25V		330		
C _{res}	Reverse Transfer Capacitance	f = 1MHz		220		
Q _g	Total gate Charge	V _{GS} = 15V		330		nC
Q _{ge}	Gate – Emitter Charge	V _{Bus} = 600V		35		
Q _{gc}	Gate – Collector Charge	I _C = 50A		200		
T _{d(on)}	Turn-on Delay Time	Inductive Switching (25°C)		35		ns
T _r	Rise Time	V _{GE} = 15V		65		
T _{d(off)}	Turn-off Delay Time	V _{Bus} = 600V		320		
T _f	Fall Time	I _C = 50A		30		
T _{d(on)}	Turn-on Delay Time	Inductive Switching (125°C)		35		ns
T _r	Rise Time	V _{GE} = ±15V		65		
T _{d(off)}	Turn-off Delay Time	V _{Bus} = 600V		360		
T _f	Fall Time	I _C = 50A		40		
E _{on}	Turn-on Switching Energy	V _{GE} = ±15V V _{Bus} = 600V	T _j = 125°C	6.9		mJ
E _{off}	Turn-off Switching Energy	I _C = 50A R _G = 5 Ω	T _j = 125°C	3.05		
R _{thJC}	Junction to Case Thermal resistance				0.4	°C/W

2.2 Bottom diode characteristics

Symbol	Characteristic	Test Conditions	Min	Typ	Max	Unit
V _{RRM}	Maximum Peak Repetitive Reverse Voltage		1200			V
I _{RM}	Maximum Reverse Leakage Current	V _R = 1200V			250	μA
		T _j = 25°C			500	
I _F	DC Forward Current			30		A
V _F	Diode Forward Voltage	I _F = 30A		2	2.5	V
		I _F = 60A		2.3		
		I _F = 30A	T _j = 125°C	1.8		
t _{rr}	Reverse Recovery Time	I _F = 30A V _R = 800V	T _j = 25°C	370		ns
			T _j = 125°C	500		
Q _{rr}	Reverse Recovery Charge	di/dt = 200A/μs	T _j = 25°C	660		nC
			T _j = 125°C	3450		
R _{thJC}	Junction to Case Thermal resistance				1.2	°C/W

3. Temperature sensor

NTC (see application note APT0406 on www.microsemi.com for more information).

Symbol	Characteristic	Min	Typ	Max	Unit
R ₂₅	Resistance @ 25°C		50		kΩ
B _{25/85}	T ₂₅ = 298.15 K		3952		K

$$R_T = \frac{R_{25}}{\exp \left[B_{25/85} \left(\frac{1}{T_{25}} - \frac{1}{T} \right) \right]}$$

T: Thermistor temperature
 R_T: Thermistor value at T

4. Package characteristics

Symbol	Characteristic	Min	Typ	Max	Unit	
V_{ISOL}	RMS Isolation Voltage, any terminal to case $t=1$ min, $I_{isol}<1$ mA, 50/60Hz	2500			V	
T_J	Operating junction temperature range	-40		150*	°C	
T_{STG}	Storage Temperature Range	-40		125		
T_C	Operating Case Temperature	-40		100		
Torque	Mounting torque	To heatsink	M4	2.5	4.7	N.m
Wt	Package Weight				160	g

$T_J=175^{\circ}\text{C}$ for Trench & Field Stop IGBT

5. SP3 Package outline (dimensions in mm)

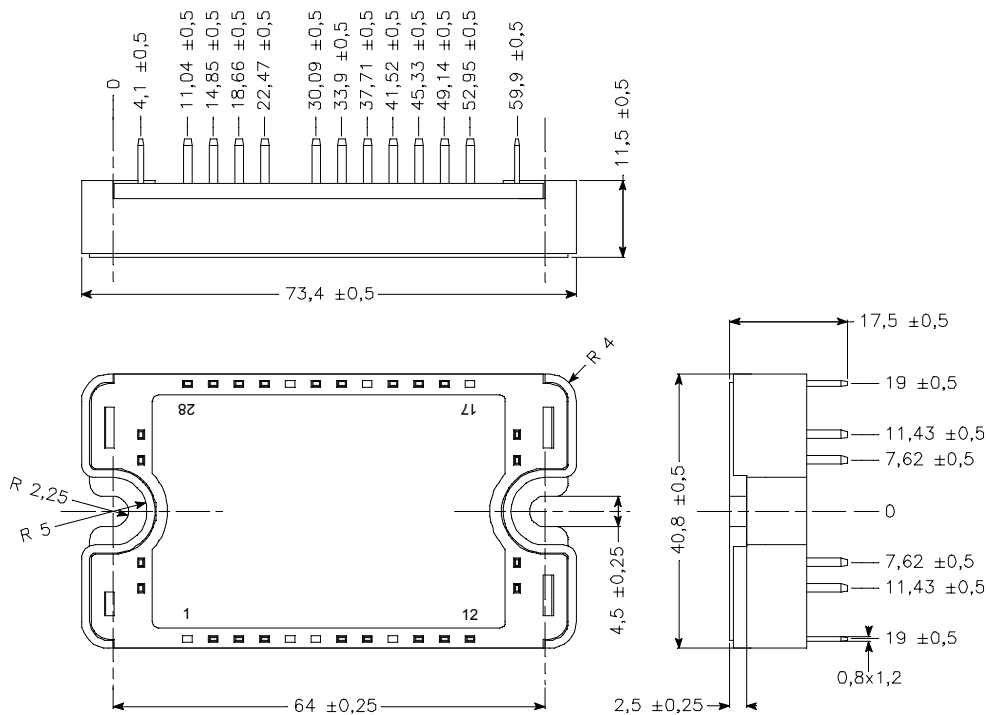

See application note 1901 - Mounting Instructions for SP3 Power Modules on www.microsemi.com

6. Top switches curves

6.1 Top Trench + Field Stop IGBT® typical performance curves

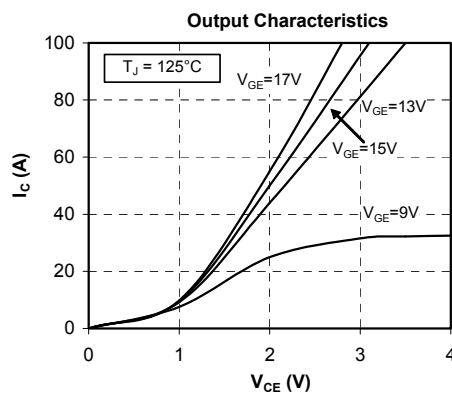
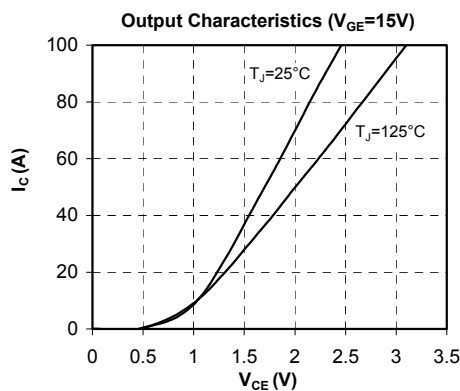

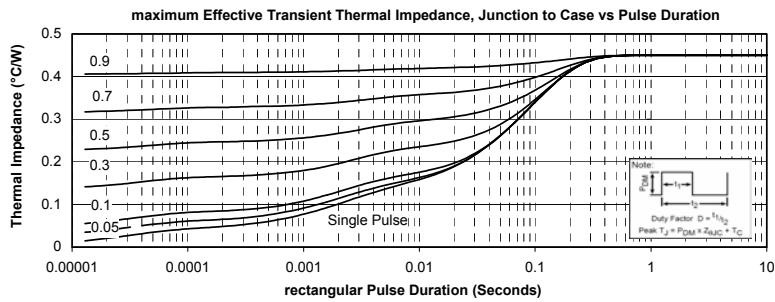
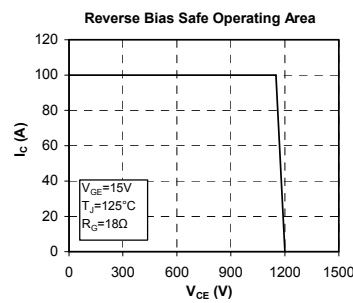
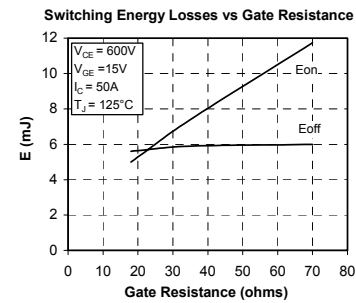
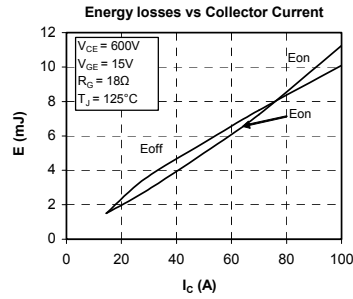
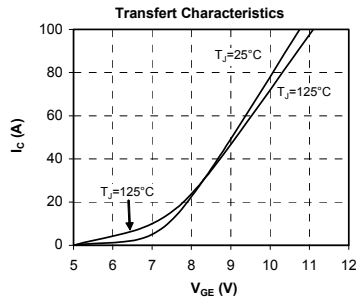

6.2 Top Fast diode typical performance curves

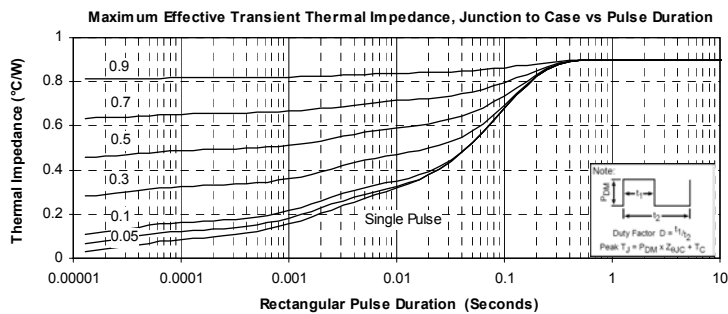
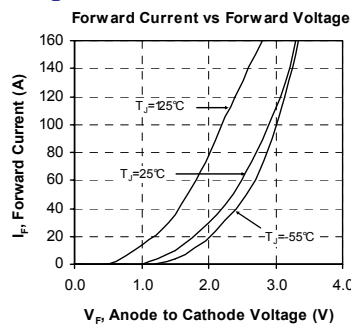

7. Bottom switches curves

7.1 Bottom fast NPT IGBT typical performance curves

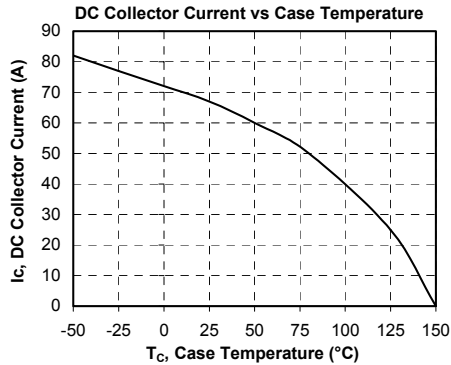
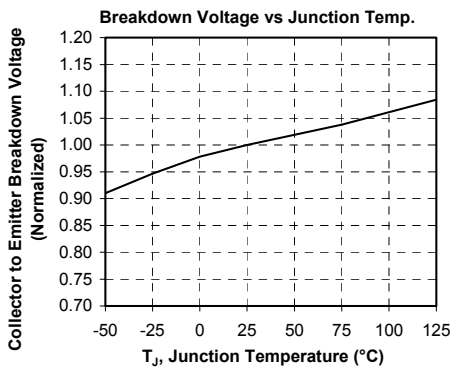
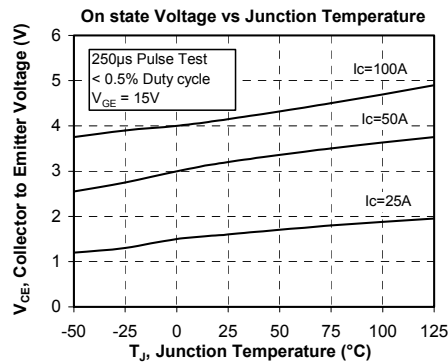
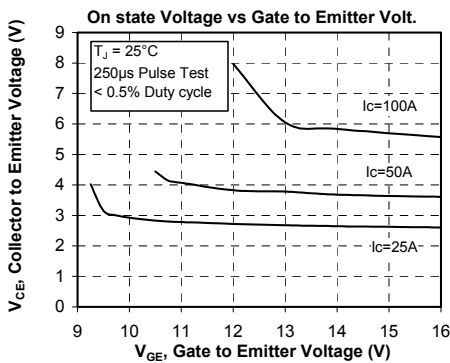
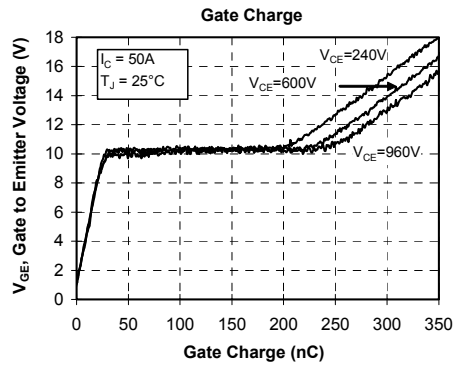
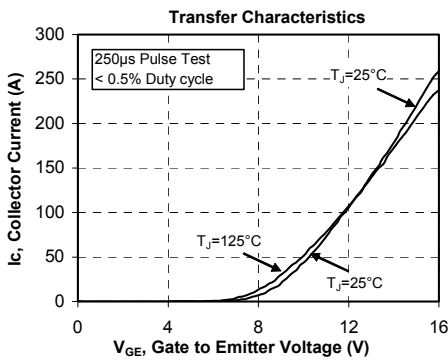
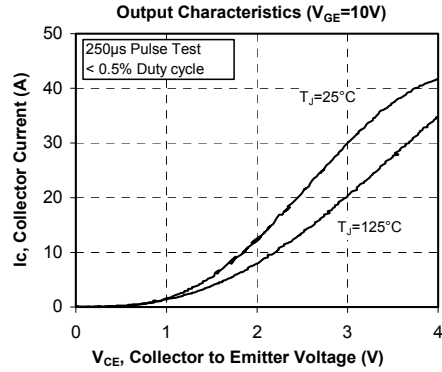
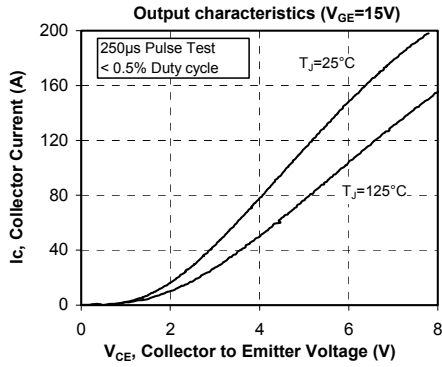

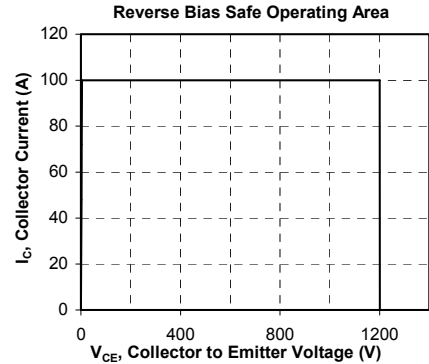
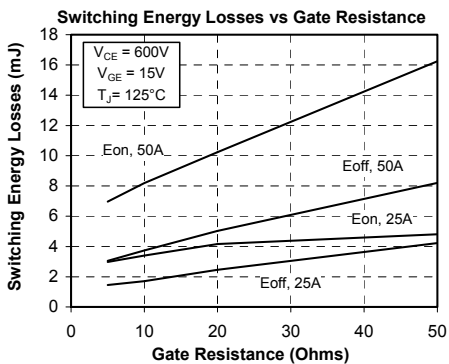
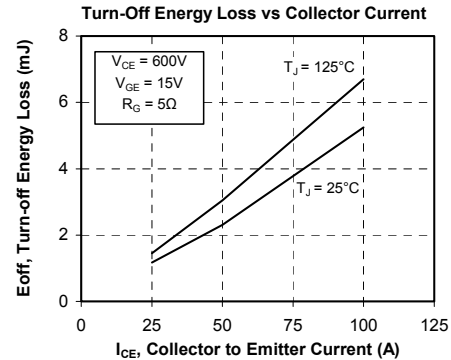
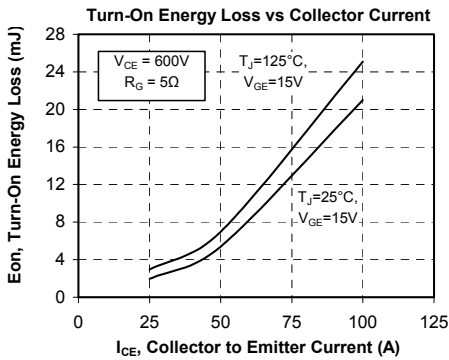
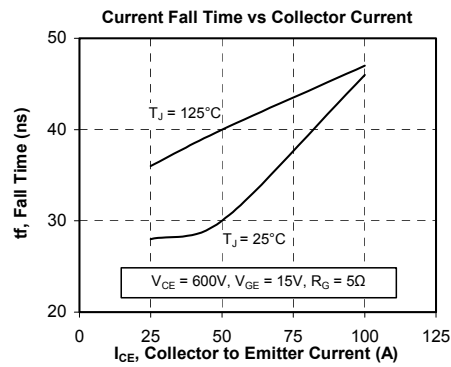
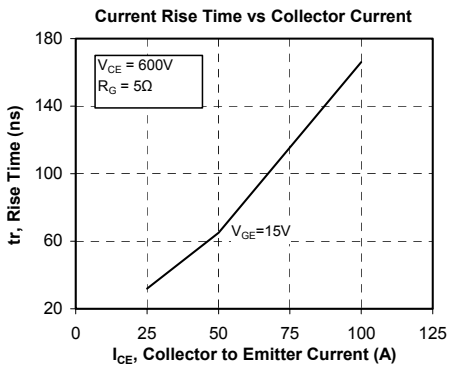
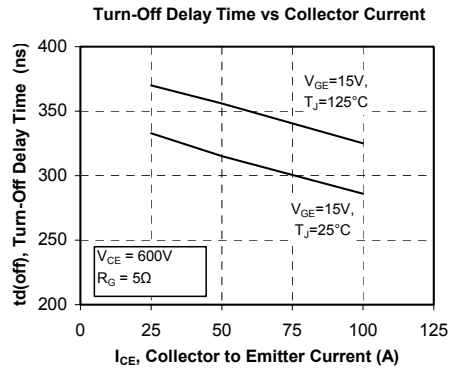
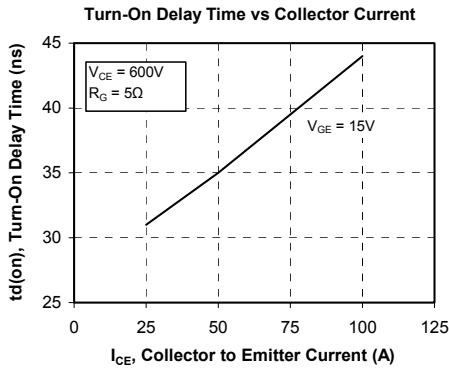

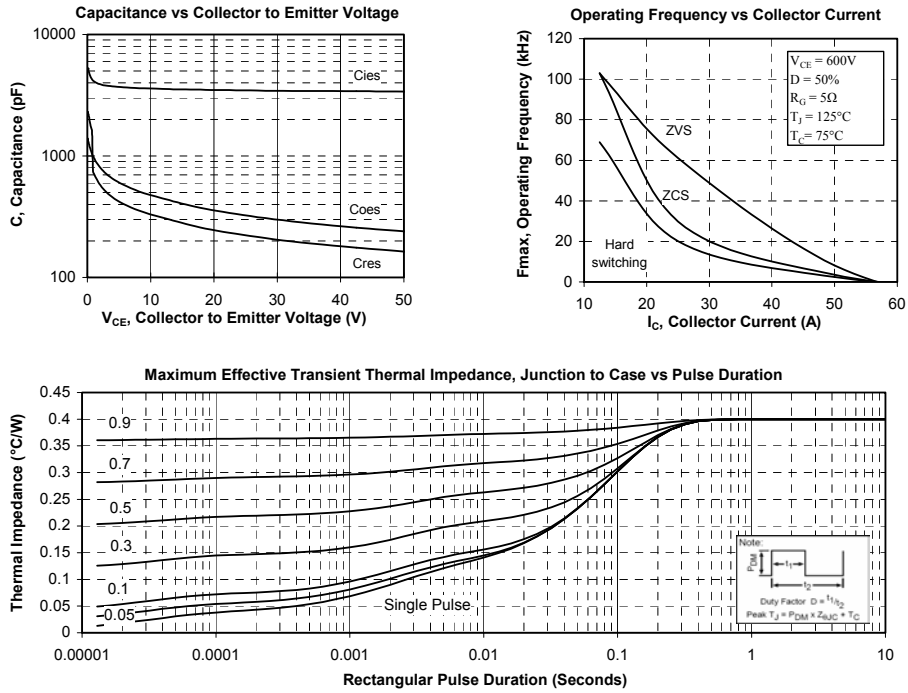

7.2 Bottom diode typical performance curves

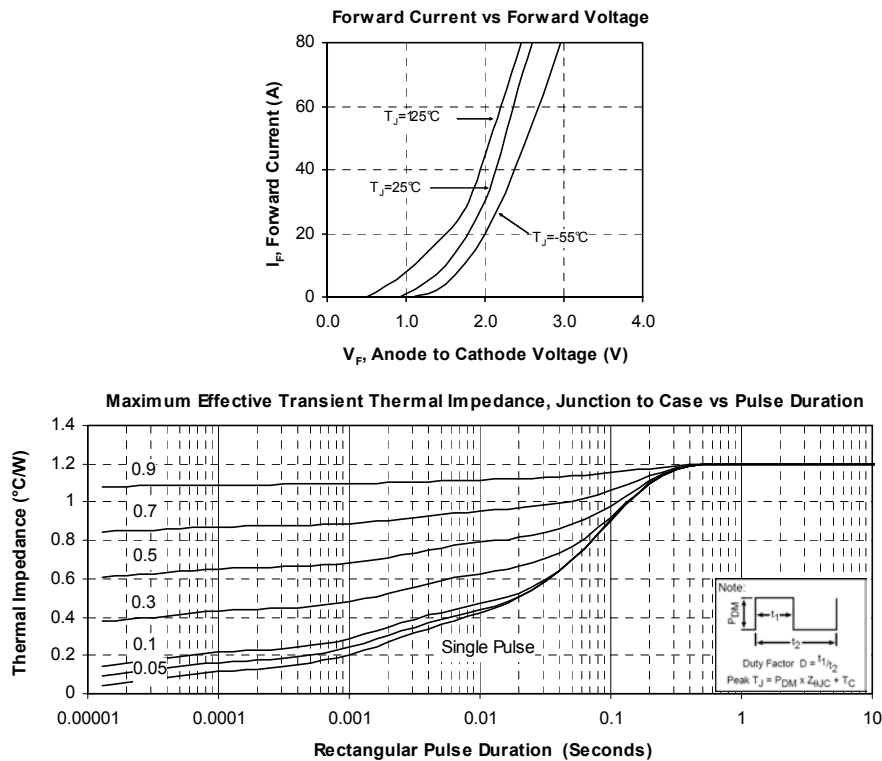

Microsemi reserves the right to change, without notice, the specifications and information contained herein

Microsemi's products are covered by one or more of U.S. patents 4,895,810 5,045,903 5,089,434 5,182,234 5,019,522 5,262,336 6,503,786 5,256,583 4,748,103 5,283,202 5,231,474 5,434,095 5,528,058 and foreign patents. U.S. and Foreign patents pending. All Rights Reserved.